



Your Vision, Our Future

**TJF-Q180V**  
Cleaning and Disinfection Checklist

# TJF-Q180V

## Cleaning and Disinfection Checklist

This checklist is used to evaluate and confirm if cleaning and disinfection of the TJF-Q180V has been performed as instructed in the Olympus reprocessing manual. The reprocessing technician should perform cleaning and disinfection of the endoscope in the same way as routine reprocessing without referring to this checklist. The evaluator stands next to the reprocessing technician and checks the reprocessing work using this checklist. After that, the evaluator determines whether or not there was any deviation in the reprocessing process.

**WARNING:** The reprocessing technician must not use this checklist while performing reprocessing as it may pose an infection control risk.

Facility name

S/N of TJF-Q180V

Procedure No. or Patient ID No.

Procedure date

### Reprocessing

**WARNING:** The reprocessing technician must not sign this checklist while performing reprocessing as it may pose an infection control risk.

Technician: Print name

Signature

Date

Technician: Print name

Signature

Date

Evaluator: Print name

Signature

Date

# Contents

General Policy .....	3
Automated Endoscope Reprocessor .....	4
Precleaning (at the patient bed side).....	5
Leakage Testing of the Endoscope .....	9
Manually Cleaning the Endoscope and Accessories .....	12
Manual High-Level Disinfection.....	31
Rinsing.....	39
Alcohol Flush.....	45
Cleaning and Disinfection using an Automated Endoscope Reprocessor .....	49

## General Policy

<p><b>1</b> Reprocessing technician should receive sufficient education on the following items:</p> <ul style="list-style-type: none"> <li>• Professional health and safety policies of the facility</li> <li>• Structure and handling of endoscope and accessories</li> <li>• Handling of pertinent chemicals</li> <li>• Cleaning and Disinfection procedure of TJF-Q180V</li> </ul>	Received	Not received
Reprocessing Technician name:		
Reprocessing Technician name:	Received	Not received
<p><b>2</b> Maintain an internal system of identifying contaminated versus reprocessed endoscopes and accessories to prevent both mix-ups and cross-contamination.</p>	Established	Not established
<p><b>3</b> In the event that the TJF-Q180V has been repaired by a non-Olympus facility, contact that repair facility for instructions regarding reprocessing. Instructions provided in the TJF-Q180V REPROCESSING MANUAL are not valid for Olympus devices repaired by a non-Olympus facility. The Olympus recommended reprocessing procedures have not been validated for reprocessing devices repaired by a non-Olympus facility.</p>	Not repaired	Repaired
<p><b>4</b> Document as performed items such as: local SOPs (standard operating procedures), confirmation of technician training, routine testing of the disinfectant's MEC (minimal effective concentration), confirmation of the disinfectant's use-life, etc.</p>	Documented	Not documented
<p><b>5</b> For leakage testing and manual cleaning of the endoscope and accessories, use either fresh, potable tap water or water that has been processed (e.g., filtered, deionized or purified) to improve its chemical and/or microbiological quality. Consult with your hospital's infection control committee.</p>	Complete	Not complete
<p><b>6</b> Establish a local policy regarding the method and frequency of cleaning and disinfecting the endoscope storage cabinet, which staff members can access the cabinet, which items can be stored in the cabinet, etc.</p>	Established	Not established
<b>Evaluation of the "General Policy"</b>	No deviation	Deviation

Deviation Comments:

## Automated Endoscope Reprocessor (AER) Policy

- |          |  |           |               |               |
|----------|--|-----------|---------------|---------------|
| <b>1</b> | Confirm that the manufacturer of the AER has validated compatibility of the AER with the TJF-Q180V.<br>Only Olympus-recommended or Olympus-endorsed AERs have been validated by Olympus.   | Confirmed | Not confirmed | N/A           |
| <b>2</b> | Before using an AER, confirm that it is capable of reprocessing the TJF-Q180V including all channels, the forceps elevator recess, and accessories.<br><br>If you are uncertain as to the ability of your AER to reprocess the TJF-Q180V including all channels, the forceps elevator recess, and accessories, contact the manufacturer of the AER for specific instructions and information on compatibility and required connectors. |           | Capable       | Not capable   |
| <b>3</b> | Confirm availability of all required connectors.<br><br>For details concerning appropriate connectors, refer to the instructions of the AER manufacturer.  |           | Confirmed     | Not confirmed |

<b>Evaluation of the “Automated Endoscope Reprocessor” Policy</b>	No deviation	Deviation
---	--------------	-----------

Deviation Comments:

Date

Procedure finish time

Precleaning start time

Precleaning technician

## Precleaning (at the patient bed side)

### Preparation

- |          |  |          |              |
|----------|--|----------|--------------|
| <b>1</b> | Immediately following the patient procedure, with the endoscope still connected to the equipment used in the patient procedure (i.e., the light source, video system center, suction pump), turn the video system center and light source OFF. | Complete | Not complete |
| <b>2</b> | Prepare a clean 1000 ml container of water.  | Complete | Not complete |

### Wipe the insertion section

- |          |  |          |              |
|----------|--|----------|--------------|
| <b>3</b> | Dip a clean, lint-free cloth or sponge in the clean water and wipe the entire insertion section of the endoscope. Wipe from the boot at the control section toward the distal end. | Complete | Not complete |
|----------|--|----------|--------------|

### Aspirate water

- |          |                                    |          |              |
|----------|------------------------------------|----------|--------------|
| <b>4</b> | Turn the suction pump ON.          | Complete | Not complete |
| <b>5</b> | Close the cap on the biopsy valve. | Complete | Not complete |

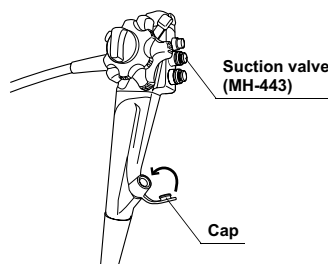

- |          |   |          |              |
|----------|---|----------|--------------|
| <b>6</b> | Lower the forceps elevator by turning the elevator control lever.   | Complete | Not complete |
| <b>7</b> | Immerse the distal end of the insertion section in the clean water. | Complete | Not complete |

(continued on next page)

**8** Depress the suction valve (MH-443) on the endoscope and aspirate the water through the endoscope for 30 seconds. 30 seconds complete Not complete

**9** While continuing the immersion and the aspiration, raise and lower the forceps elevator three times, by turning the elevator control lever. Raise/Lower 3 times complete Not complete



**10** Remove the distal end from the water. Complete Not complete

**11** Depress the suction valve and aspirate air for 10 seconds. 10 seconds complete Not complete

**12** Turn the suction pump OFF. Complete Not complete

**Flush the air/water channel with water and air**

**13** Turn the light source ON. Complete Not complete

**14** Switch OFF the airflow regulator on the light source. Complete Not complete

**15** Detach the air/water valve (MH-438) from the endoscope and place it in the detergent solution. Complete Not complete

*(continued on next page)*

- |           |   |          |              |
|-----------|---|----------|--------------|
| <b>16</b> | Attach the AW channel cleaning adapter (MH-948) to the air/water cylinder of the endoscope. | Complete | Not complete |
|-----------|---|----------|--------------|

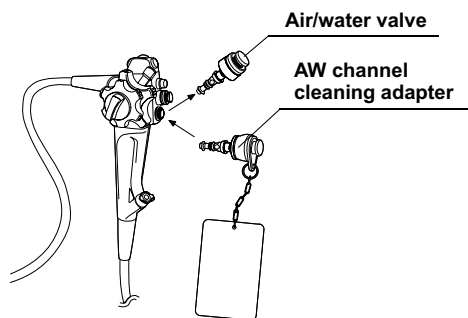

- |           |   |          |              |
|-----------|---|----------|--------------|
| <b>17</b> | Immerse the distal end of the insertion section in the clean water. | Complete | Not complete |
|-----------|---|----------|--------------|

- |           |   |          |              |
|-----------|---|----------|--------------|
| <b>18</b> | Switch the airflow regulator on the light source to maximum output (“HIGH” or “3”). | Complete | Not complete |
|-----------|---|----------|--------------|

- |           |  |                     |              |
|-----------|--|---------------------|--------------|
| <b>19</b> | Depress the button of the AW channel cleaning adapter to flush the air/water channel with water from the water container for 30 seconds. | 30 seconds complete | Not complete |
|-----------|--|---------------------|--------------|

- |           |   |                     |              |
|-----------|---|---------------------|--------------|
| <b>20</b> | Release the button to flush air for 10 seconds. | 10 seconds complete | Not complete |
|-----------|---|---------------------|--------------|

- |           |                            |          |              |
|-----------|----------------------------|----------|--------------|
| <b>21</b> | Turn the light source OFF. | Complete | Not complete |
|-----------|----------------------------|----------|--------------|

**Detach accessories from the endoscope**

- |           |  |          |              |
|-----------|--|----------|--------------|
| <b>22</b> | Detach the videoscope cable (MAJ-1430, MAJ-843, or MH-976) from the electrical connector of the endoscope. | Complete | Not complete |
|-----------|--|----------|--------------|

- |           |  |          |              |
|-----------|--|----------|--------------|
| <b>23</b> | Detach the suction tube from the suction connector on the endoscope connector. | Complete | Not complete |
|-----------|--|----------|--------------|

- |           |   |          |              |
|-----------|---|----------|--------------|
| <b>24</b> | Detach the metal tip of the water container (MAJ-901 or MH-884) from the air/water supply connector on the endoscope connector. | Complete | Not complete |
|-----------|---|----------|--------------|

*(continued on next page)*





## Leakage Testing of the Endoscope

- |          |   |          |              |
|----------|---|----------|--------------|
| <b>1</b> | Detach the endoscope from the light source.   | Complete | Not complete |
| <b>2</b> | Transport the endoscope to the reprocessing area. Use a covered container if required by local policy.  | Complete | Not complete |
| <b>3</b> | Detach the AW channel cleaning adapter (MH-948), the suction valve (MH-443), and the biopsy valve (MB-358) from the endoscope and place them in the detergent solution.   | Complete | Not complete |
| <b>4</b> | When using the single use biopsy valve (MAJ-1555), detach the single use biopsy valve from the endoscope and discard it.  | Complete | Not complete |
| <b>5</b> | Fill a clean, large basin with water.   | Complete | Not complete |
| <b>6</b> | Attach the leakage tester connector of the leakage tester (MB-155) to the output socket of the maintenance unit (MU-1) or the light source. Turn the maintenance unit or the light source ON. Set the light source's airflow regulator switch to its maximum level. | Complete | Not complete |
| <b>7</b> | Depress the pin located inside the connector cap of the leakage tester and listen to confirm that air is emitted from the connector cap.  | Complete | Not complete |

*(continued on next page)*

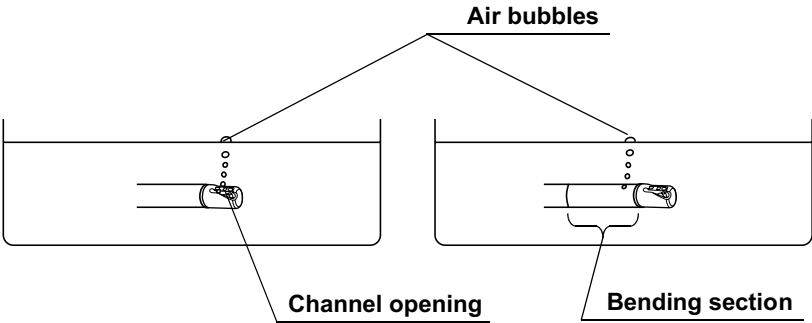
<b>8</b> Confirm that both the connector cap of the leakage tester and the venting connector of the water resistant cap are dry. If not, dry with a clean, lint free cloth. Attach the connector cap to the venting connector by pushing on and rotating clockwise until it stops.	Complete	Not complete
<b>9</b> With the leakage tester attached, immerse the endoscope in the water. Observe for approximately 30 seconds while deflecting the bending section of the endoscope by turning the endoscope's UP/DOWN and RIGHT/LEFT angulation control knobs to confirm that there is no location on the endoscope from which a continuous series of air bubbles emerges. Then observe for additional 30 seconds while raising and lowering the forceps elevator by moving the endoscope's elevator control lever to confirm that there is no location around the forceps elevator from which a continuous series of air bubbles emerges during the 30 seconds.	Performed	Not performed
	Deflected	Not deflected
	Raised and lowered	Not raised and lowered
	No leakage	Leakage
<b>10</b> Remove the endoscope from the water with the leakage tester still attached.	Complete	Not complete
<b>11</b> Turn the maintenance unit or the light source OFF.	Complete	Not complete
<b>12</b> Detach the leakage tester from the maintenance unit or the light source.	Complete	Not complete
<b>13</b> Wait 30 seconds, or until the covering of the bending section contracts to its pre-expansion size. Detach the leakage tester from the water resistant cap.	Complete	Not complete
<b>14</b> Thoroughly dry the leakage tester using a clean, lint-free cloth.	Complete	Not complete

(continued on next page)

## Evaluation of the “Leakage Testing”

No deviation

Deviation

Deviation Comments:

## Manually Cleaning the Endoscope and Accessories

### Clean the external surface

**1** Fill a clean, large basin with the detergent solution at the concentration recommended by the detergent manufacturer. Complete    Not complete

Use a medical-grade, low-foaming, neutral pH detergent. Follow the instructions provided by the detergent manufacturer regarding concentration, temperature, contact time, and expiration date.

**Actual Condition**

Detergent Name:

Concentration:

Temperature:

Contact time:

Expiration date:

**2** Immerse the endoscope in the detergent solution. Complete    Not complete

**3** Thoroughly brush or wipe all external surfaces of the endoscope, using a clean, lint-free cloths, brushes or sponges. Pay particular attention to the air/water nozzle opening and the objective lens on the distal end of the insertion section, and ensure that all surfaces of the distal end are thoroughly cleaned. All external surfaces complete    Not complete

Distal end complete    Not complete

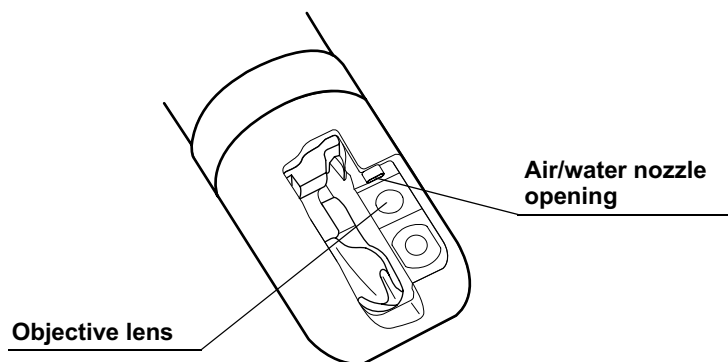

*(continued on next page)*

## Brush the forceps elevator and elevator recess

**4** Lower the forceps elevator by turning the elevator control lever in the opposite direction of the “◀U” direction until the forceps elevator stops. Perform the following brushing in the detergent solution.

Complete      Not complete

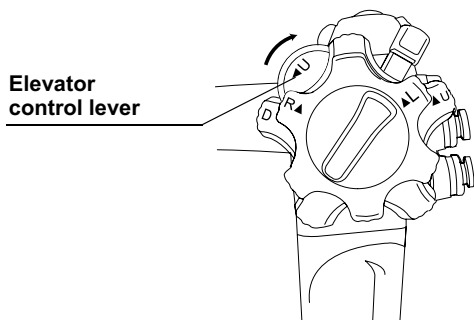

**5** Straighten the bending section of the endoscope.

Complete      Not complete

**6** Brush the forceps elevator including the guidewire-locking groove and the forceps elevator recess with the single use channel-opening cleaning brush (MAJ-1339) or the single use combination cleaning brush (BW-412T) as follows:

a) Insert the brush into the forceps elevator recess along the forceps elevator until the brush handle touches the distal end of the endoscope and pull the brush out of the forceps elevator recess in the detergent solution.

Brush handle touched      Not complete

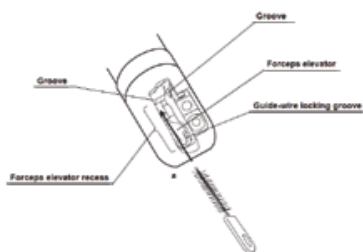

b) Repeat the insertion and withdrawal 3 times.

Completed 3 times      Not completed

c) Brush the guidewire-locking groove in the detergent solution.

Complete      Not complete

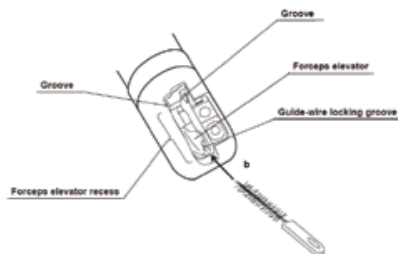

(continued on next page)

Ver.1.4 (January 2016) Olympus Medical Systems Corp.

**7** Raise the forceps elevator by turning the elevator control lever in the “◀U” direction until the forceps elevator stops.

Complete      Not complete

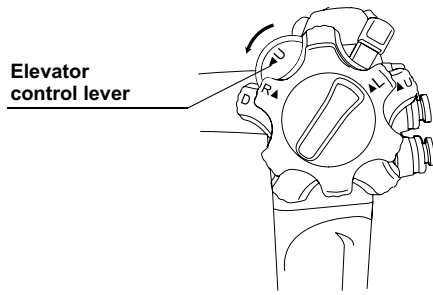

**8** While holding the distal end, brush the forceps elevator and the forceps elevator recess with the single-use channel-opening cleaning brush as follows:

a) Insert the brush into the forceps elevator recess along the back of the forceps elevator until the distal end of the brush touches the bottom of the forceps elevator recess and pull the brush out of the forceps elevator recess

Complete      Not complete

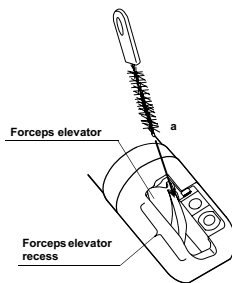

b) Insert the brush into the forceps elevator recess, rotate the brush one full revolution and pull the brush out of the forceps elevator recess.

Insertion complete      Not complete

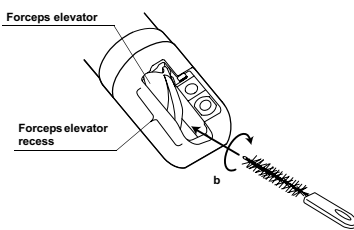

Rotation complete      Not complete

**9** Operate the elevator control lever to lower and raise the forceps elevator in the detergent solution at least three times.

3 times complete      Not complete



*(continued on next page)*

<b>10</b>	Clean the bristles of the brush in the detergent solution using your gloved fingertips to remove any debris.	Complete	Not complete
<b>11</b>	Lower the forceps elevator by turning the elevator control lever in the opposite direction of the “◀U” direction until the forceps elevator stops.	Complete	Not complete
<b>12</b>	Brush the distal end of the endoscope except the forceps elevator and the forceps elevator recess, using the single use channel-opening cleaning brush, until no debris is observed upon inspection of the distal end of the endoscope.	Brushing complete	Not complete
		No debris confirmed	Debris confirmed

### Brush the channels

<b>13</b>	Confirm that no parts remain inside either the instrument channel or the suction channel of the endoscope by carefully passing a new brush through both channels.	Instrument channel complete	Instrument channel not complete
		Suction channel complete	Suction channel not complete
		No parts	Parts

### Brush from the suction cylinder to the distal end of the insertion section

<b>14</b>	Straighten the bending section of the endoscope. Grip the channel cleaning brush (BW 20T), or the channel cleaning brush part of the single use combination cleaning brush (BW-412T), at a point 3 cm from the bristles.	Complete	Not complete
-----------	--	----------	--------------

(continued on next page)



**15** Insert the brush at a 45° angle into the opening located in the side wall of the suction cylinder. Using short strokes, feed the brush through the instrument channel until it emerges from the distal end of the endoscope's insertion section.

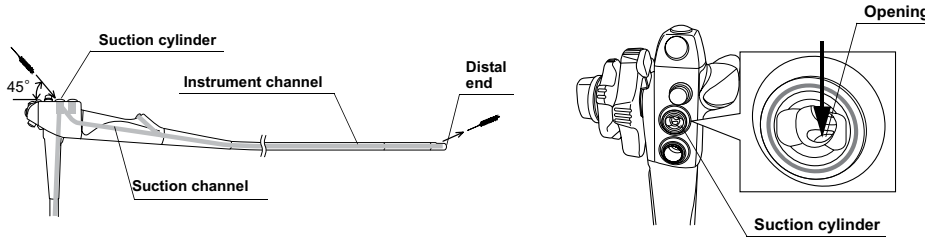

Short strokes	Long strokes
Emerged	Not emerged
	Not brushed

**16** Inspect whether there is debris on the bristles when the brush emerges from the distal end. Clean the bristles in the detergent solution using your gloved fingertips to remove any debris.

Inspection complete	Inspection not complete
Cleaning complete	Cleaning not complete

**17** Carefully pull the brush back through the channel and out of the suction cylinder.

Complete	Not complete
----------	--------------

**18** Inspect whether there is debris on the bristles when the brush emerges from the suction cylinder. Clean the bristles in the detergent solution using your gloved fingertips to remove any debris.

Inspection complete	Inspection not complete
Cleaning complete	Cleaning not complete

**19** Repeat steps 15 through 18 until no debris is observed upon inspection of the brush.

No debris observed	Debris observed
--------------------	-----------------

19 Complete

20 Complete	Not complete
-------------	--------------

21 Complete

No debris observed	Debris observed
--------------------	-----------------

(continued on next page)

<b>20</b>	Inspect whether no debris is observed on the brush (Inspection by the evaluator).	No debris observed	Debris observed
	<b>WARNING</b> - The evaluator must not touch the endoscope. That may pose an infection control risk.		

**Brush from the suction cylinder to the endoscope connector**

<b>21</b>	Insert the brush straight into the suction cylinder. Using short strokes, feed the brush through the suction channel until it emerges from the suction connector on the endoscope connector.	Short strokes	Long strokes
-----------	--	---------------	--------------

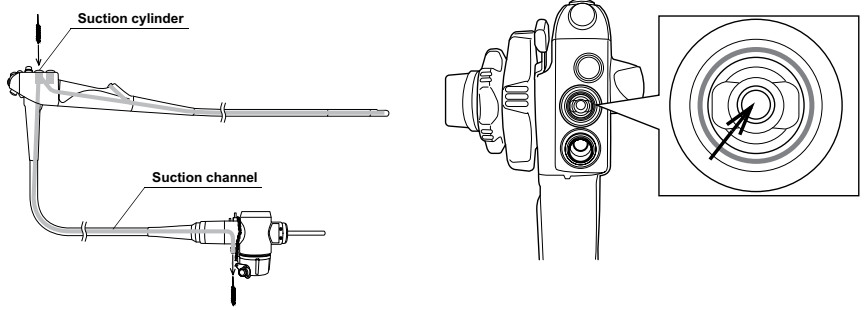

Emerged	Not emerged
	Not brushed

<b>22</b>	Inspect whether there is debris on the bristles when the brush emerges from the suction connector. Clean the bristles in the detergent solution using your gloved fingertips to remove any debris.	Inspection complete	Inspection not complete
-----------	--	---------------------	-------------------------

Cleaning complete	Cleaning not complete
-------------------	-----------------------

<b>23</b>	Carefully pull the brush back through the channel and out of the suction cylinder.	Complete	Not complete
-----------	--	----------	--------------

<b>24</b>	Inspect whether there is debris on the bristles when the brush emerges from the suction cylinder. Clean the bristles in the detergent solution using your gloved fingertips to remove any debris.	Inspection complete	Inspection not complete
-----------	---	---------------------	-------------------------

Cleaning complete	Cleaning not complete
-------------------	-----------------------

<b>25</b>	Repeat steps 21 through 24 until no debris is observed upon inspection of the brush.	No debris observed	Debris observed
		21 Complete	
		22 Complete	Not complete
		24 Complete	
		No debris observed	Debris observed
<b>26</b>	Inspect whether no debris is observed on the brush (Inspection by the evaluator). <b>WARNING</b> - The evaluator must not touch the endoscope. That may pose an infection control risk.	No debris observed	Debris observed

**Brush the suction cylinder**

<b>27</b>	Insert the single use channel-opening cleaning brush into the suction cylinder, until half of the brush section is inserted.	Complete	Not complete
-----------	--	----------	--------------

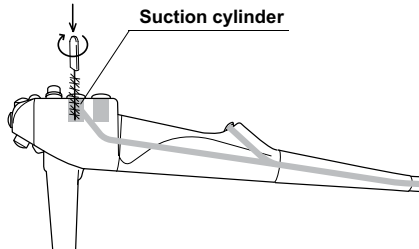

<b>28</b>	Rotate the inserted brush one full revolution.	Complete	Not complete
-----------	--	----------	--------------

<b>29</b>	Pull the brush out of the cylinder.	Complete	Not complete
-----------	-------------------------------------	----------	--------------

**30** Inspect whether there is debris on the bristles. Clean the bristles in the detergent solution using your gloved fingertips to remove any debris.

Inspection complete      Inspection not complete

Cleaning complete      Cleaning not complete

**31** Repeat steps 27 through 30 until no debris is observed upon inspection of the brush.

No debris observed      Debris observed

27 Complete

28 Complete      Not complete

30 Complete

No debris observed      Debris observed

**32** Inspect whether no debris is observed on the brush (Inspection by the evaluator).

No debris observed      Debris observed

**WARNING** - The evaluator must not touch the endoscope. That may pose an infection control risk.

### Brush the instrument channel port

**33** Insert the single use channel-opening cleaning brush (MAJ-1339), the channel-opening cleaning brush part of the single use combination cleaning brush (BW-412T), into the instrument channel port, until the brush handle touches the channel opening.

Complete      Not complete

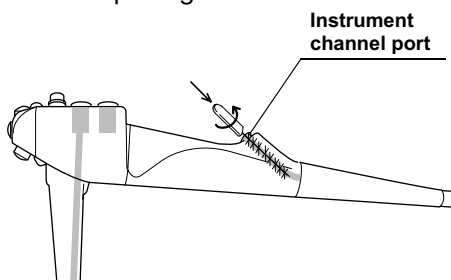

**34** Rotate the inserted brush one full revolution.

Complete      Not complete

*(continued on next page)*

<b>35</b>	Pull the brush out of the instrument channel port.	Complete	Not complete
<b>36</b>	Inspect whether there is debris on the bristles. Clean the bristles in the detergent solution using your gloved fingertips to remove any debris.	Inspection complete	Inspection not complete
		Cleaning complete	Cleaning not complete
<b>37</b>	Repeat Steps 33 through 36 until no debris is observed upon inspection of the brush.	No debris observed	Debris observed
		33 Complete	
		34 Complete	Not complete
		36 Complete	
		No debris observed	Debris observed
<b>38</b>	Inspect whether no debris is observed on the brush (Inspection by the evaluator). <b>WARNING</b> - The evaluator must not touch the endoscope. That may pose an infection control risk.	No debris observed	Debris observed

*(continued on next page)*

39 Dispose of the single use channel-opening cleaning brush. Complete Not complete

40 Remove the endoscope from the detergent solution. Complete Not complete

**Aspirate detergent solution through the instrument channel and the suction channel**

41 Attach the suction cleaning adapter (MH-856) to the instrument channel port. Complete Not complete

42 Attach the suction tube from the suction pump to the suction connector on the endoscope connector. Complete Not complete

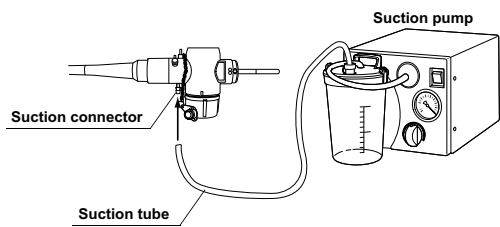

43 Turn the suction pump ON. Complete Not complete

44 Confirm that the forceps elevator is lowered, and immerse both the distal end of the insertion section and the weighted end of the suction cleaning adapter in the detergent solution. Confirm lowered Not lowered

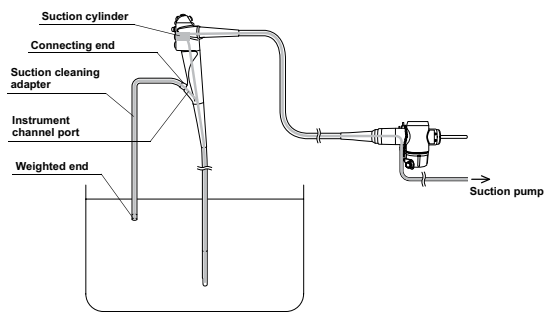

(continued on next page)

- |           |   |                        |              |
|-----------|---|------------------------|--------------|
| <b>45</b> | Cover the suction cylinder of the endoscope with your gloved finger and aspirate the detergent solution through the instrument channel and the suction channel of the endoscope for approximately 30 seconds. | 30 seconds<br>complete | Not complete |
|-----------|---|------------------------|--------------|

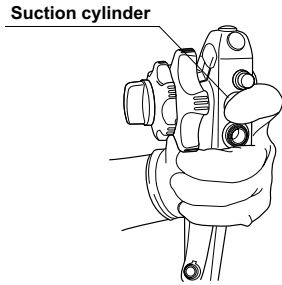

- |           |  |                        |              |
|-----------|--|------------------------|--------------|
| <b>46</b> | While continuing the immersion and the aspiration, raise and lower the forceps elevator three times. | Raise/lower<br>3 times | Not complete |
|-----------|--|------------------------|--------------|



- |           |                            |          |              |
|-----------|----------------------------|----------|--------------|
| <b>47</b> | Turn the suction pump OFF. | Complete | Not complete |
|-----------|----------------------------|----------|--------------|

- |           |  |          |              |
|-----------|--|----------|--------------|
| <b>48</b> | Detach the suction tube and the suction cleaning adapter from the endoscope. | Complete | Not complete |
|-----------|--|----------|--------------|

**Brush and flush the forceps elevator recess with detergent solution**

- |           |   |          |              |
|-----------|---|----------|--------------|
| <b>49</b> | Immerse the distal end in detergent solution. | Complete | Not complete |
|-----------|---|----------|--------------|

- |           |  |          |              |
|-----------|--|----------|--------------|
| <b>50</b> | Confirm that the forceps elevator is lowered, and straighten the bending section of the endoscope. | Complete | Not complete |
|-----------|--|----------|--------------|

*(continued on next page)*

**51** Brush the forceps elevator and the forceps elevator recess with the single use soft brush (MAJ-1888) as follows, keeping the distal end of the endoscope immersed in the detergent solution:

a) Brush the guidewire-locking groove with three strokes;



3 strokes  
complete

Not complete

b) Brush both grooves with three strokes each.

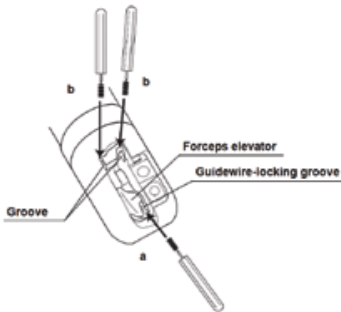

3 strokes  
complete

Not complete

**52** Clean the bristles of the brush gently with your fingertips in the detergent solution.

Complete

Not complete

**53** Raise the forceps elevator.

Complete

Not complete

**54** Brush the whole back side of the forceps elevator three times, keeping the distal end immersed in the detergent solution

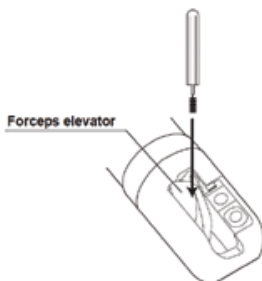

3 times  
complete

Not complete



**55** Clean the bristles of the brush gently with your fingertips in the detergent solution. Complete Not complete

**56** Insert the brush head slowly into the groove under the forceps elevator until the end of the brush touches the wall behind the elevator. Complete Not complete

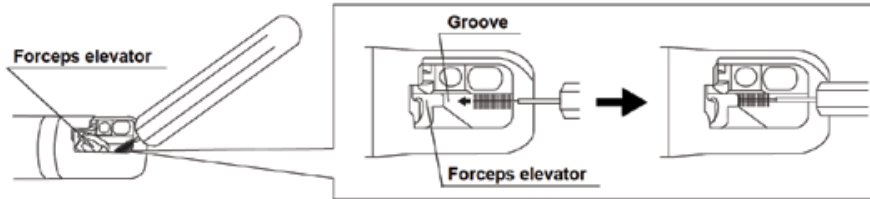

**57** Rotate the inserted brush three revolutions while ensuring the end of the brush is contacting the wall behind the forceps elevator, and while keeping distal end of the endoscope immersed in the detergent solution. 3 times complete Not complete

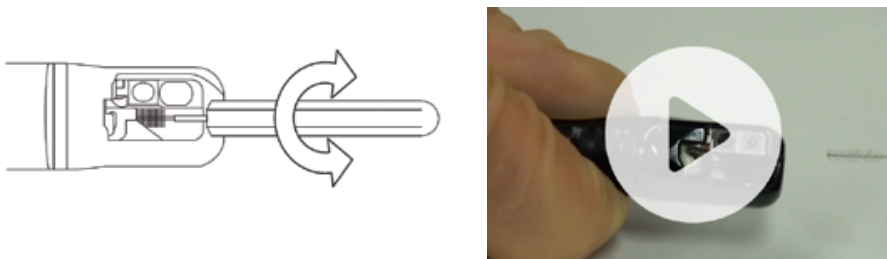

**58** Pull the brush out slowly and gently clean the bristles in the detergent solution with your fingertips. Complete Not complete

**59** Operate the elevator control lever to lower and raise the forceps elevator at least three times, keeping the distal end of the endoscope immersed in the detergent solution. 3 times complete Not complete



<b>60</b>	Confirm that the forceps elevator is raised.	Complete	Not complete
-----------	--	----------	--------------

<b>61</b>	Insert the tip of the 30 ml syringe into the interior of the forceps elevator recess in the detergent solution, and flush the interior of the recess with 30 ml of the detergent solution.	Insertion complete	Insertion not complete
-----------	--	--------------------	------------------------

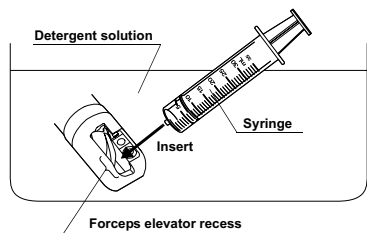

Flushing complete	Flushing not complete
-------------------	-----------------------

<b>62</b>	Lower the forceps elevator by turning the elevator control lever in the opposite direction of the “◀U” direction until it stops.	Complete	Not complete
-----------	--	----------	--------------

<b>63</b>	Insert the tip of the 30 ml syringe into the interior of the forceps elevator recess in the detergent solution, and flush the interior of the recess with 30 ml of the detergent solution.	Flushing complete	Not complete
-----------	--	-------------------	--------------



<b>64</b>	Repeat steps 56 through 63.	Complete	Not complete
-----------	-----------------------------	----------	--------------

<b>65</b>	Inspect whether there is debris on the forceps elevator and in the forceps elevator recess while raising and lowering the forceps elevator. (Inspection by the reprocessing technician).	No debris confirmed on the elevator	Debris confirmed on the elevator
-----------	--	-------------------------------------	----------------------------------

No debris confirmed in the recess	Debris confirmed in the recess
-----------------------------------	--------------------------------

*(continued on next page)*

<b>66</b>	Inspect whether there is debris on the forceps elevator and in the forceps elevator recess while raising and lowering the forceps elevator. (Inspection by the evaluator).	No debris confirmed on the elevator	Debris confirmed on the elevator
	<b>WARNING</b> - The evaluator must not touch the endoscope. That may pose an infection control risk.	No debris confirmed in the recess	Debris confirmed in the recess
<b>67</b>	After use, carefully check that the single use soft brush (MAJ-1888) head and/or shaft has not fallen off inside of the endoscope.	Complete	Not complete
<b>68</b>	Dispose of the brush in an appropriate manner.	Complete	Not complete

**Flush the air/water channel with detergent solution**

<b>69</b>	Attach the biopsy valve cap of the channel plug (MH-944) to the instrument channel port of the endoscope.	Complete	Not complete
-----------	---	----------	--------------

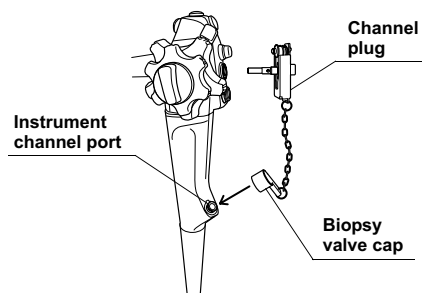

<b>70</b>	Attach the channel plug to the air/water and suction cylinders of the endoscope.	Complete	Not complete
<b>71</b>	Attach the injection tube (MH-946) to the endoscope connector.	Complete	Not complete
<b>72</b>	Immerse the suction port of the injection tube in the detergent solution.	Complete	Not complete

*(continued on next page)*

**73** Attach a clean 30 ml syringe to the air/water channel port of the injection tube. Complete Not complete

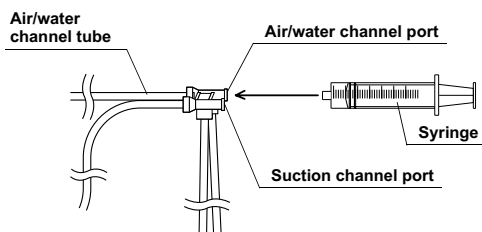

**74** Flush the air/water channel with 90 ml of the detergent solution by pumping the syringe at least three times. 3 times complete Not complete

**Immerse the endoscope and accessories in detergent solution**

**75** Wipe all external surfaces of the endoscope, the channel plug (MH-944), and the injection tube (MH-946) to remove debris while they are immersed in the detergent solution, using a clean, lint-free cloth, brush, or sponge. Complete Not complete

**76** Leave the endoscope with attached accessories immersed in the detergent solution, according to the instructions of the detergent manufacturer. Complete Not complete

**77** Remove the endoscope with attached accessories from the detergent solution. Complete Not complete

**Remove detergent solution from all channels**

**78** Fill a clean large basin with water. Complete Not complete

**79** Immerse the endoscope with attached accessories in the water and gently agitate them to thoroughly rinse. Complete Not complete

*(continued on next page)*

**80** Immerse the suction port of the injection tube (MH-946) in the water.

Complete

Not complete

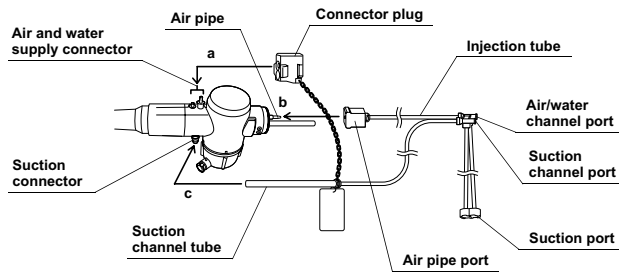

**81** Attach a clean 30 ml syringe to the suction channel port of the injection tube and flush the suction channel with 90 ml of water (i.e., pump the syringe at least three times).

Attaching complete

Attaching not complete

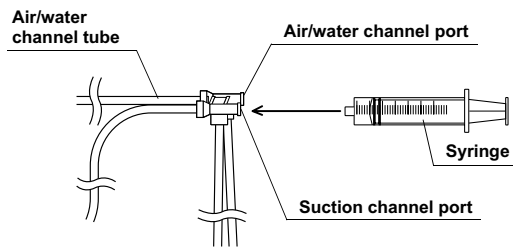

3 times flushing complete

Flushing not complete

**82** Move the syringe to the air/water channel port of the injection tube and flush the air/water channel with 90 ml of water (i.e., pump the syringe at least three times).

Moving complete

Moving not complete

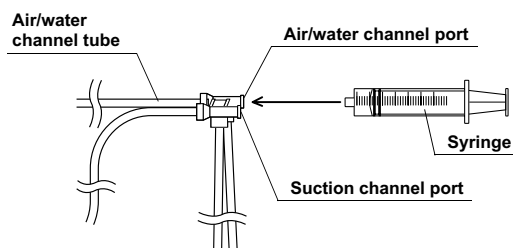

3 times flushing complete

Flushing not complete

**83** Remove the endoscope with attached accessories from the water.

Complete

Not complete

**84** Place them in a clean basin.

Complete

Not complete

**85** Cover the distal end and the control section of the endoscope with a clean, lint-free cloth(s) to prevent splashing from the channel openings.

Complete

Not complete

*(continued on next page)*

**86** Attach the syringe to the suction channel port of the injection tube and flush the suction channel with 90 ml of air.

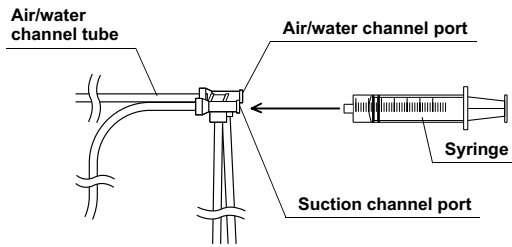

Attaching complete

Attaching not complete

3 times flushing complete

Flushing not complete

**87** Move the syringe to the air/water channel port of the injection tube and flush the air/water channel with 90 ml of air.

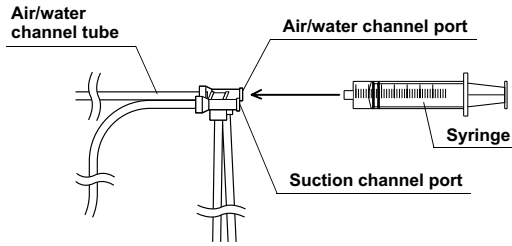

Moving complete

Moving not complete

3 times flushing complete

Flushing not complete

**88** Remove the cloth(s) from the endoscope.

Complete

Not complete

**89** Detach the channel plug and the injection tube from the endoscope.

Complete

Not complete

### Dry external surfaces

**90** Dry the external surfaces of the endoscope, the channel plug, and the injection tube by wiping with a clean, lint-free cloth(s).

Complete

Not complete

*(continued on next page)*

**91** Inspect all items for residual debris. Should any debris remain, repeat the entire cleaning procedure until all debris is removed.

Inspection complete      Inspection not complete

No debris remained      Debris remained

Repeating complete      Repeating not complete

Inspection complete      Inspection not complete

No debris remained      Debris remained

**92** Inspect whether debris is observed on the endoscope (Inspection by the evaluator).

No debris remained      Debris remained

**WARNING** - The evaluator must not touch the endoscope. That may pose an infection control risk.

**Evaluation of the “Manually Cleaning the Endoscope and Accessories”**

No deviation      Deviation

Deviation Comments:

**NOTE** - Go to page 49 for using an AER.

Start time

Reprocessing technician name

## Manual High-Level Disinfection

### Preparation

**1** Fill a clean large basin with the disinfectant solution. Complete Not complete

**2** Use a high-level disinfectant cleared by your national regulatory agency for use in reprocessing flexible endoscopes. Follow the disinfectant manufacturer's instructions regarding activation (if required), concentration, temperature, contact time, and expiration date. Complete Not complete

**Actual condition**

Detergent name:

Concentration:

Temperature:

Contact time:

Expiration date:

**3** Immerse the endoscope in the disinfectant solution. Complete Not complete

*(continued on next page)*



**4** Attach the channel plug (MH-944) and the injection tube (MH-946) to the endoscope. Complete      Not complete

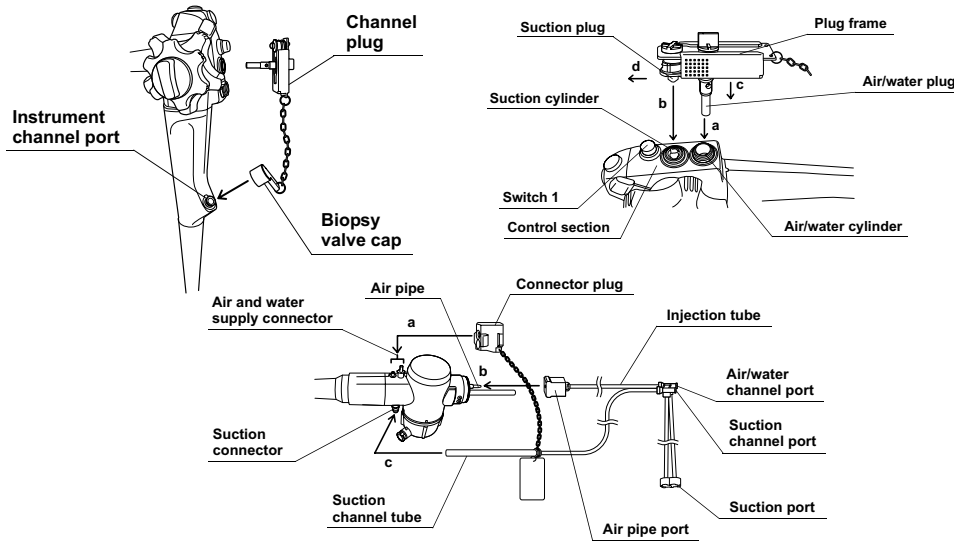

**5** Immerse in the disinfectant solution. Complete      Not complete

**Flush all channels and the forceps elevator recess with disinfectant solution**

**6** Confirm that the suction port of the injection tube (MH-946) is immersed in the disinfectant solution. Complete      Not complete

**7** Attach a clean 30 ml syringe to the suction channel port of the injection tube and forcefully flush the suction channel with 180 ml of the disinfectant solution – i.e., by pumping the syringe at least six times. Confirm that no air bubbles exit the distal end of the endoscope’s insertion section during the sixth flush. 6 times flushing complete      Flushing not complete

If air bubbles still exit, flush the channel with the disinfectant solution until no air bubbles exit. Confirmation complete      Confirmation not complete

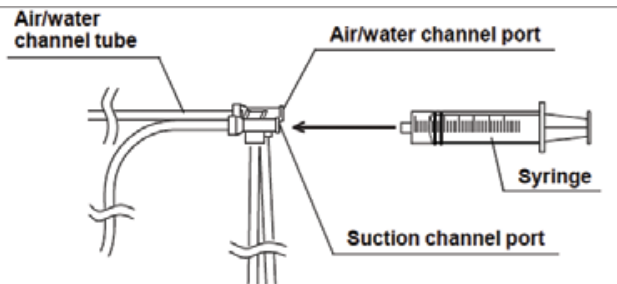

No air bubbles      Air bubbles

Additional flushing complete      Additional flushing not complete

No air bubbles      Air bubbles

*(continued on next page)*

**8** Move the syringe to the air/water channel port of the injection tube and forcefully flush the air/water channel with 180 ml of the disinfectant solution.

Confirm that no air bubbles exit the distal end during the sixth flush. If air bubbles still exit, flush the channel with the disinfectant solution until no air bubbles exit.

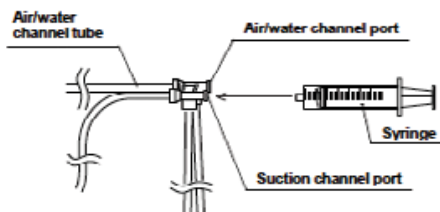

Moving complete      Moving not complete

6 times flushing complete      Flushing not complete

Confirmation complete      Confirmation not complete

No air bubbles      Air bubbles

Additional flushing complete      Additional flushing not complete

No air bubbles      Air bubbles

**9** Remove the biopsy valve cap of the channel plug (MH-944) from the instrument channel port of the endoscope, remaining the channel plug to be attached to the air/water and suction cylinders of the endoscope. Forcefully flush the instrument channel with 180 ml of the disinfectant solution, using the 30ml syringe - i.e., fill the syringe with the disinfectant solution without air, put the distal end of the syringe in the instrument channel port in the disinfectant solution, and forcefully flush at least six times, minimizing disinfectant solution leakage from the port.

Confirm that no air bubbles exit the distal end of the endoscope's insertion section during the sixth flush. If air bubbles still exit, flush the channel with the disinfectant solution until no air bubbles exit.

Moving complete      Moving not complete

6 times flushing complete      Flushing not complete

Confirmation complete      Confirmation not complete

No air bubbles      Air bubbles

Additional flushing complete      Additional flushing not complete

No air bubbles      Air bubbles



**10** Raise the forceps elevator by turning the elevator control lever in the “◀U” direction until resistance is felt.

Complete      Not complete

*(continued on next page)*

**11** Insert the tip of the 30 ml syringe into the interior of the forceps elevator recess in the disinfectant solution, and flush the interior of the recess with 60 ml of the disinfectant solution.

Insertion complete

Insertion not complete

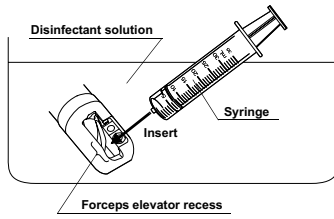

Flushing complete

Flushing not complete

**NOTE**, When using a luer-lock type syringe, the tip of the syringe may not fit into the interior of the forceps elevator recess. In this case, hold the tip of the syringe over the interior of the recess while the syringe contacts the surface of the endoscope.

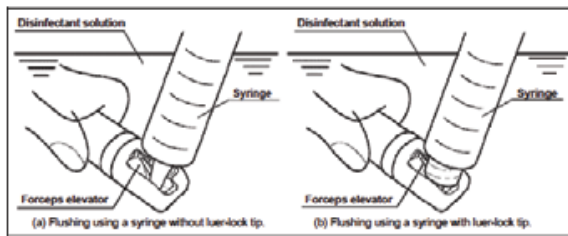

**12** Lower the forceps elevator by turning the elevator control lever. Insert the tip of the 30 ml syringe into the interior of the forceps elevator recess in the disinfectant solution, and flush the interior of the recess with 60 ml of the disinfectant solution.

Complete

Not complete

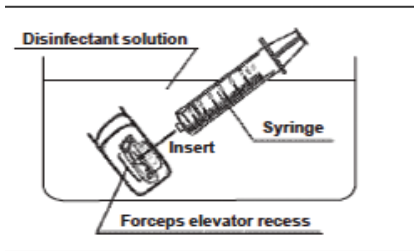

**NOTE**, When using a luer-lock type syringe, the tip of the syringe may not fit into the interior of the forceps elevator recess. In this case, hold the tip of the syringe over the interior of the recess while the syringe contacts the surface of the endoscope.

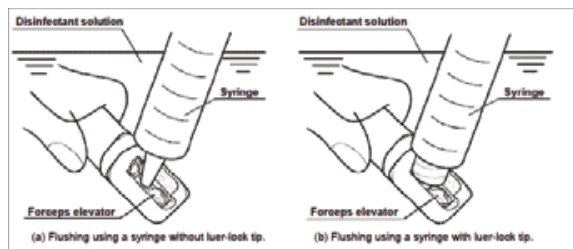

(continued on next page)

**13** Turn the elevator control lever to raise and lower the forceps elevator three times, keeping the distal end of the endoscope immersed in the disinfectant solution

Complete

Not complete



**14** Forcefully flush the instrument channel with 90ml of the disinfectant solution, using the 30ml syringe - i.e., fill the syringe with the disinfectant solution without air, put the distal end of the syringe in the instrument channel port in the disinfectant solution, and forcefully flush at least three times, minimizing disinfectant solution leakage from the port. Confirm that no air bubbles exit the distal end of the endoscope's insertion section during the third flush. If air bubbles still exit, flush the channel with the disinfectant solution until no air bubbles exit.

Complete

Not complete



Repeat the steps 10-14 above.

### Immerse the endoscope and accessories in disinfectant solution

**15** Detach the syringe from the accessories. While immersed, detach the channel plug (MH-944) and the injection tube (MH-946) from the endoscope.

Complete

Not complete

**16** Confirm that the endoscope and all accessories are completely submerged in the disinfectant solution.

Complete

Not complete

*(continued on next page)*

<b>17</b> Confirm that there are no air bubbles on the surfaces of the endoscope and accessories. If air bubbles adhere to the surfaces, wipe them away using your gloved finger or a clean, lint-free cloth.	Confirmed	Not confirmed
	No air bubbles	Air bubbles
	Wiping complete	Wiping not complete
	No air bubbles	Air bubbles

<b>18</b> Cover the basin of the disinfectant solution with a tight-fitting lid to minimize the diffusion of disinfectant vapors.	Complete	Not complete
---	----------	--------------

<b>19</b> Leave the endoscope, the channel plug, and the injection tube immersed in the disinfectant solution according to the instructions of the disinfectant manufacturer. Confirm the recommended contact time, temperature, and concentration. Use a clock or timer to accurately measure the disinfection contact time.	Leaving complete	Leaving not complete
	Using complete	Using not complete

**Actual condition**

Start time and date:

Reprocessing technician name:

Actual immersion time:

Expiration date:

(From the above leaving start time to the start time of this section)

**Labeled condition**

Labeled immersion time:

*(continued on next page)*

## Remove the endoscope and accessories from disinfectant solution

- 20** Attach the channel plug (MH-944) and the injection tube (MH-946) to the endoscope. Complete      Not complete

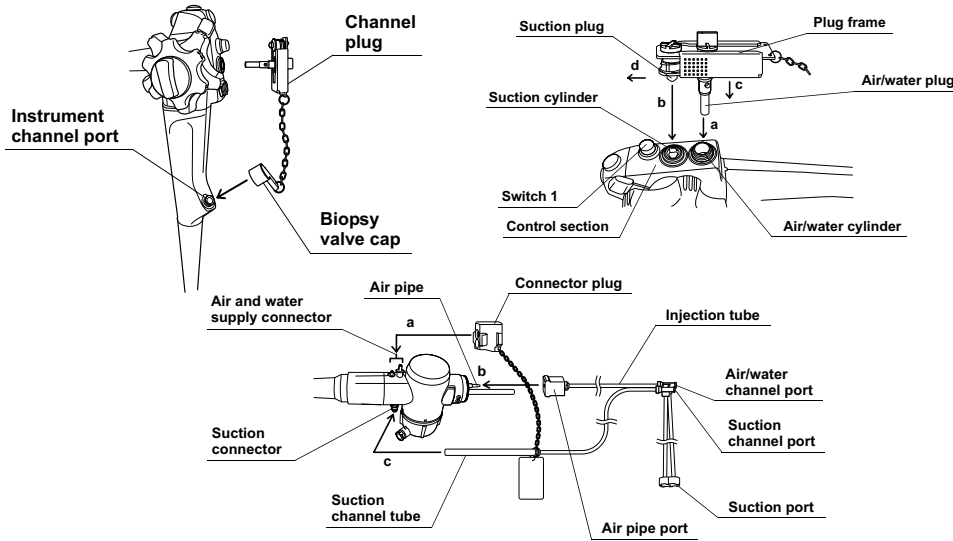

- 21** Remove the suction port of the injection tube from the disinfectant solution. Complete      Not complete

- 22** Attach a sterile 30 ml syringe to the suction channel port of the injection tube and flush the suction channel with 90 ml of air – i.e., pump the syringe at least three times. Attaching complete      Attaching not complete

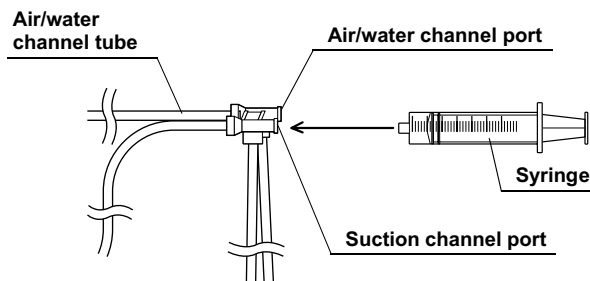

- 3 times  
flushing  
complete      Flushing not  
complete

*(continued on next page)*

**23** Move the syringe to the air/water channel port of the injection tube and flush the air/water channel with 90 ml of air.

Moving Complete Not complete

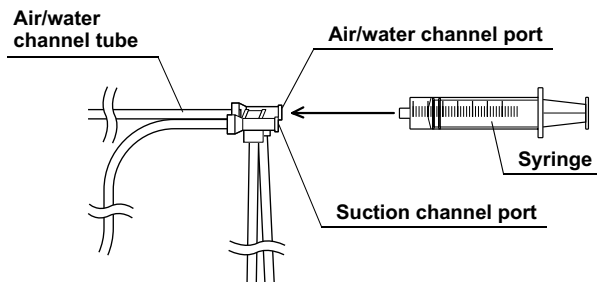

3 times flushing complete Flushing not complete

**24** Remove the endoscope with attached accessories from the disinfectant solution.

Complete Not complete

**Evaluation of the “Manual High-Level Disinfection”**

No deviation Deviation

Deviation Comments:

# Rinsing

- 1 Use sterile water, either fresh, potable tap water, or water that has been processed (e.g., filtered, deionized, or purified) to improve its chemical and/or microbiological quality, and flush the endoscope and accessories with the alcohol after rinsing. Consult with your hospital's infection control committee regarding local policies on water quality.

**Actual condition**

Sterile water

Fresh water

Potable water

Other:

## Rinse the endoscope and accessories

- |          |  |          |              |
|----------|--|----------|--------------|
| <b>2</b> | Fill a sterile large basin with the rinse water.   | Complete | Not complete |
| <b>3</b> | Immerse the endoscope with attached accessories in the rinse water.                            | Complete | Not complete |
| <b>4</b> | Detach the channel plug (MH-944) and injection tube (MH-946) from the endoscope.               | Complete | Not complete |
| <b>5</b> | Wipe all external surfaces of the endoscope and accessories, using a sterile, lint-free cloth. | Complete | Not complete |
| <b>6</b> | Attach the channel plug and the injection tube to the endoscope.                               | Complete | Not complete |

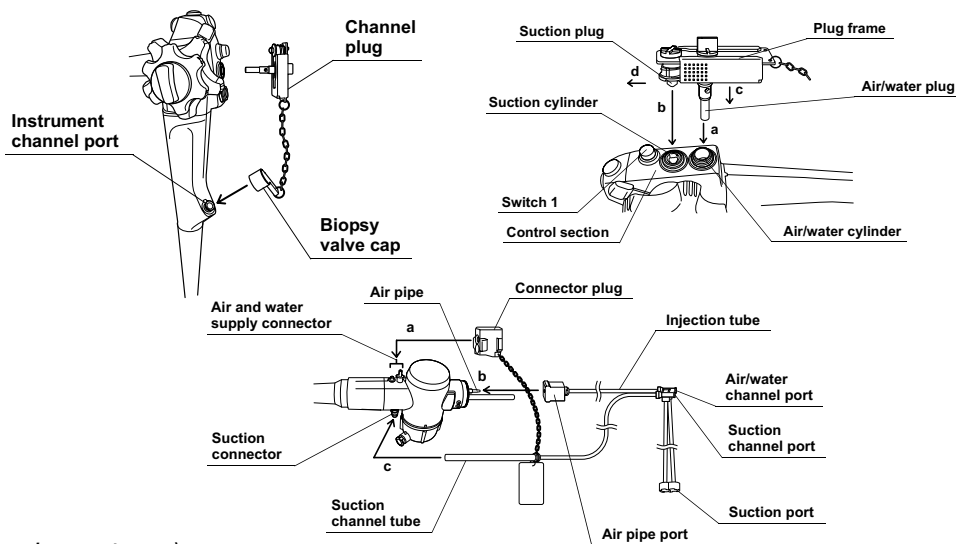

(continued on next page)



<b>7</b>	Immerse the suction port of the injection tube in the rinse water.	Complete	Not complete
----------	--	----------	--------------

<b>8</b>	Attach a sterile 30 ml syringe to the suction channel port of the injection tube and flush the suction channel with 90 ml of the rinse water – i.e., pump the syringe at least three times.	Attaching complete	Attaching not complete
----------	---	--------------------	------------------------

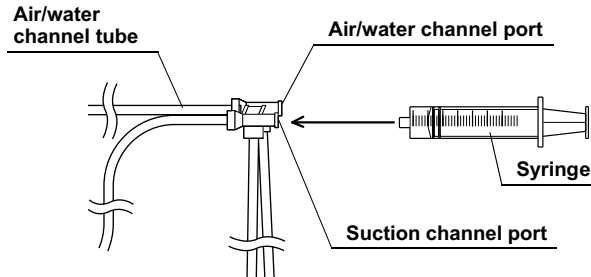

3 times flushing complete	Flushing not complete
---------------------------	-----------------------

<b>9</b>	Move the syringe to the air/water channel port of the injection tube and flush the air/water channel with 90 ml of the rinse water.	Moving complete	Moving not complete
----------	---	-----------------	---------------------

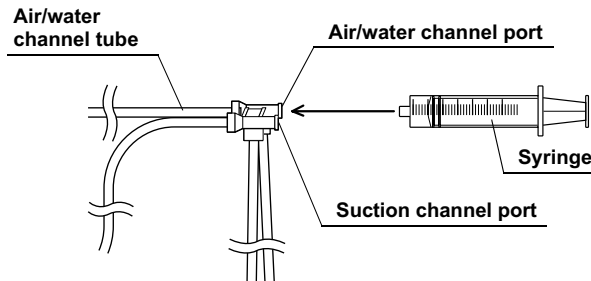

3 times flushing complete	Flushing not complete
---------------------------	-----------------------

<b>10</b>	Raise the forceps elevator by turning the elevator control lever in the “◀U” direction until resistance is felt.	Complete	Not complete
-----------	--	----------	--------------

(continued on next page)

**11** Insert the tip of the 30 ml syringe into the interior of the forceps elevator recess in the rinse water, and flush the interior of the recess with 30 ml of the rinse water.

Insertion complete

Insertion not complete

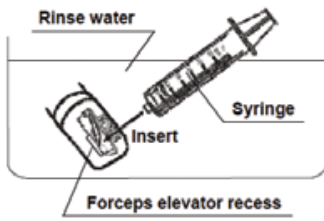

Flushing complete

Flushing not complete

**NOTE**, When using a luer-lock type syringe, the tip of the syringe may not be fit into the interior of the forceps elevator recess. In this case, hold the tip of the syringe over the interior of the recess while the syringe contacts the surface of the endoscope.

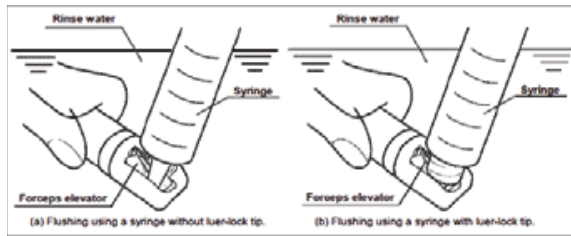

**12** Lower the forceps elevator by turning the elevator control lever. Insert the tip of the 30 ml syringe into the interior of the forceps elevator recess in the rinse water, and flush the interior of the recess with 30 ml of the rinse water.

Complete

Not complete

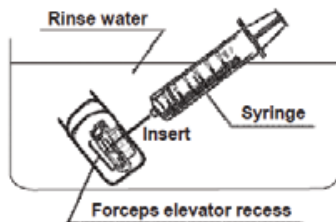

**NOTE**, When using a luer-lock type syringe, the tip of the syringe may not be fit into the interior of the forceps elevator recess. In this case, hold the tip of the syringe over the interior of the recess while the syringe contacts the surface of the endoscope.

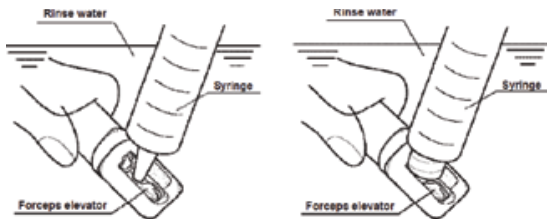

(continued on next page)

**13** Turn the elevator control lever to raise and lower the forceps elevator three times, keeping the distal end of the endoscope immersed in the rinse water.

3 times  
complete

Not complete



Repeat the step 1-13 above for the necessary number of times, following the rinsing method described in the disinfectant solution manual.

**14** By turning the elevator control lever, put the forceps elevator in intermediate position of the range of movement.

Complete

Not complete

**15** Remove the endoscope with attached accessories from the rinse water and place them in a sterile basin.

Complete

Not complete

**16** Cover the distal end and the control section of the endoscope with a sterile, lint-free cloth(s) to prevent splashing from the channel openings.

Complete

Not complete

**17** Attach the syringe to the suction channel port of the injection tube and flush the suction channel with 90 ml of air.

Attaching  
complete

Attaching not  
complete

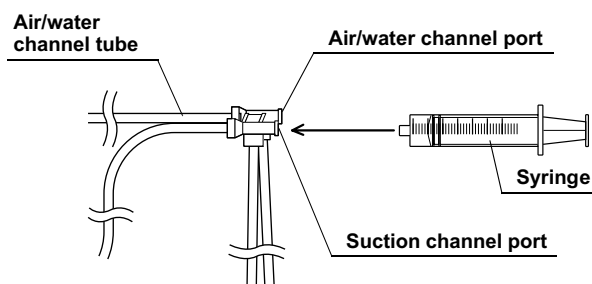

3 times  
flushing  
complete

Flushing not  
complete

**18** Move the syringe to the air/water channel port of the injection tube and flush the air/water channel with 90 ml of air.

Moving complete

Moving not complete

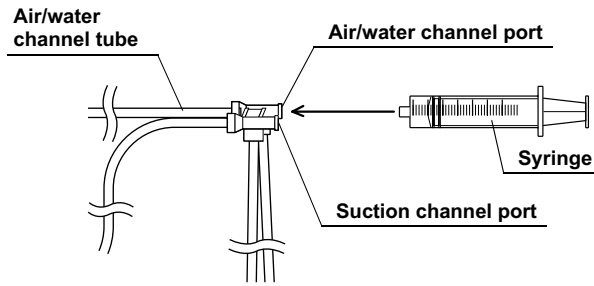

3 times flushing complete

Flushing not complete

**19** Remove the cloth(s) from the endoscope.

Complete

Not complete

**20** Detach only the injection tube from the endoscope.

Complete

Not complete

**21** Attach a sterile suction tube from the suction pump to the suction connector on the endoscope connector.

Complete

Not complete

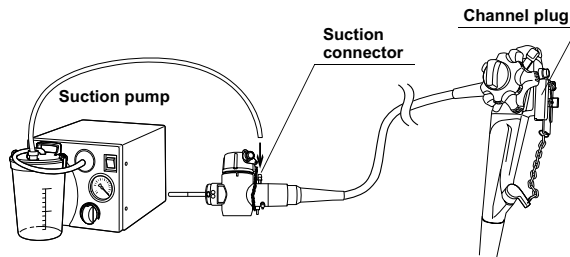

**22** Turn the suction pump ON and aspirate air for at least 15 seconds. Air will flow through the instrument channel and the suction channel of the endoscope.

Turning complete

Turning not complete

15 seconds aspiration complete

Aspiration not complete

*(continued on next page)*

**23** While continuing the aspiration, raise and lower the forceps elevator three times, by turning the elevator control lever.

3 times  
complete

Not complete



**24** Turn the suction pump OFF.

Complete

Not complete

**25** Detach the suction tube and the channel plug from the endoscope.

Complete

Not complete

**26** Thoroughly dry the external surfaces of the endoscope, the channel plug, and the injection tube, by wiping with a sterile, lint-free cloth(s).

Complete

Not complete

**27** Thoroughly dry the inside of the suction cylinder, the air/water cylinder, the instrument channel port of the endoscope, and the forceps elevator recess, while raising and lowering the forceps elevator, using a sterile cotton swab(s).

Complete

Not complete

### **Evaluation of the “Rinsing”**

No deviation

Deviation

Deviation Comments:

## Alcohol Flush

Use medical-grade 70% ethyl or 70% isopropyl alcohol.

70% ethyl  
alcohol used

Other used

70%  
isopropyl  
alcohol used

## Alcohol Flush

- |          |  |          |              |
|----------|--|----------|--------------|
| <b>1</b> | Fill a sterile small basin with the alcohol.                                       | Complete | Not complete |
| <b>2</b> | Attach the channel plug (MH-944) and the injection tube (MH-946) to the endoscope. | Complete | Not complete |

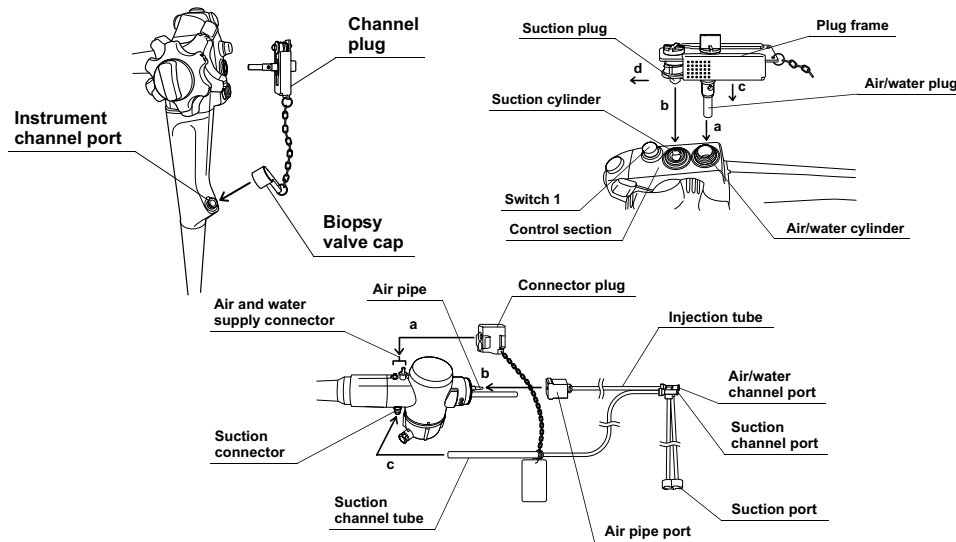

- |          |  |          |              |
|----------|--|----------|--------------|
| <b>3</b> | Immerse the suction port of the injection tube in the alcohol.   | Complete | Not complete |
| <b>4</b> | Cover the distal end and the control section of the endoscope with a sterile, lint-free cloth(s) to prevent splashing alcohol from the channel openings. | Complete | Not complete |

*(continued on next page)*

**5** Attach a sterile 30 ml syringe to the suction channel port of the injection tube and flush the suction channel with 90 ml of the alcohol – i.e., pump the syringe at least three times.

Attaching complete

Attaching not complete

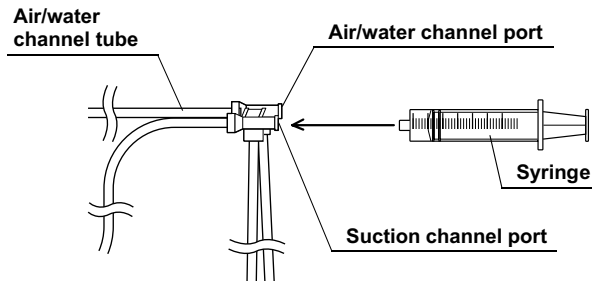

3 times flushing complete

Flushing not complete

**6** Move the syringe to the air/water channel port of the injection tube and flush the air/water channel with 30 ml of the alcohol.

Moving complete

Moving not complete

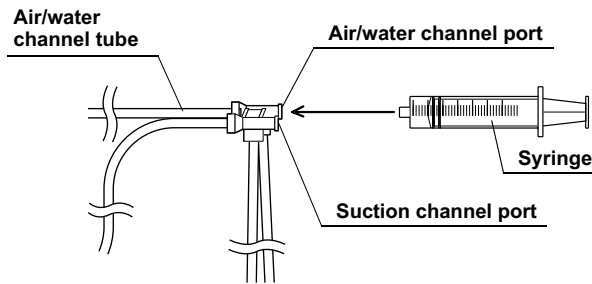

Flushing 3 times complete

Flushing not complete

**7** Raise the forceps elevator by turning the elevator control lever in the “◀U” direction until resistance is felt.

Complete

Not complete

**8** Insert the tip of the 30 ml syringe into the interior of the forceps elevator recess, under covering the cloth(s) and flush the interior of the recess with 30 ml of alcohol.

Insertion complete

Insertion not complete

**NOTE**, When using a luer-lock type syringe, the tip of the syringe may not be fit into the interior of the forceps elevator recess. In this case, hold the tip of the syringe over the interior of the recess while the syringe contacts the surface of the endoscope.

Flushing complete

Flushing not complete

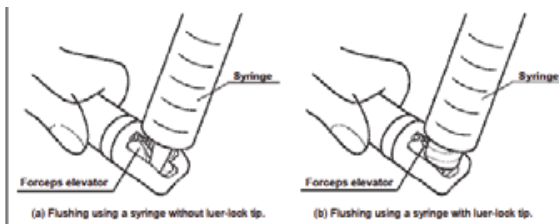

(continued on next page)

**9** Lower the forceps elevator by turning the elevator control lever. Insert the tip of the 30 ml syringe into the interior of the forceps elevator recess, under covering the cloth(s) and flush the interior of the recess with 30 ml of the alcohol.

Complete      Not complete

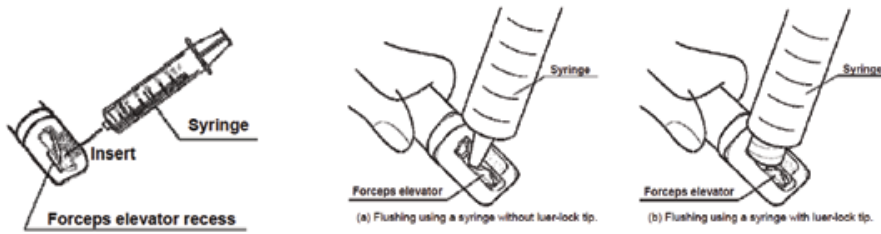

**NOTE**, When using a luer-lock type syringe, the tip of the syringe may not be fit into the interior of the forceps elevator recess. In this case, hold the tip of the syringe over the interior of the recess while the syringe contacts the surface of the endoscope.

**10** Turn the elevator control level to raise and lower the forceps elevator three times.

Complete      Not complete



**11** Remove the suction port of the injection tube from the alcohol.

Complete      Not complete

**12** Attach the syringe to the suction channel port of the injection tube and flush the suction channel with 90 ml of air.

Attaching complete      Attaching not complete

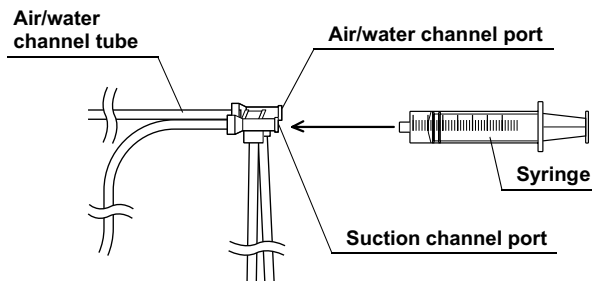

3 times flushing complete      Flushing not complete

*(continued on next page)*



**13** Move the syringe to the air/water channel port of the injection tube and flush the air/water channel with 90 ml of air.

Moving complete

Moving not complete

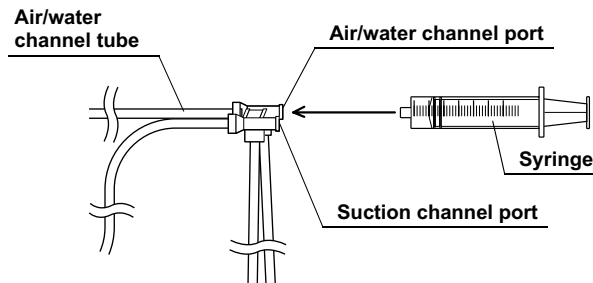

Flushing 3 times complete

Flushing not complete

**14** Remove the cloth(s) from the endoscope.

Complete

Not complete

**15** Detach the channel plug and the injection tube from the endoscope.

Complete

Not complete

**16** Thoroughly dry the external surfaces of the endoscope, the channel plug, and the injection tube, by wiping with a sterile, lint-free cloth(s).

Complete

Not complete

**17** Thoroughly dry the inside of the suction cylinder, the air/water cylinder, the instrument channel port of the endoscope, and the forceps elevator recess, while raising and lowering the forceps elevator, using a sterile cotton swab(s).

Complete

Not complete

### Evaluation of the "Alcohol Flush"

No deviation

Deviation

Deviation Comments:

## Cleaning and Disinfection using an Automated Endoscope Reprocessor (AER)

<b>1</b> Put the forceps elevator in intermediate position of the range of movement by moving the elevator control lever and set it in your AER so that the forceps elevator recess can be sufficiently cleaned and disinfected.	Complete	Not complete
<b>2</b> Inspect whether the forceps elevator is in intermediate position (inspection by the evaluator).  <b>WARNING</b> - The evaluator must not touch the endoscope. That may pose an infection control risk.	Intermediate position	Not intermediate position
<b>3</b> Place the endoscope in your AER according to the instructions of the AER manufacturer.	Complete	Not complete
<b>4</b> Connect any necessary connecting tubes in accordance with the instructions from the AER manufacturer.	Complete	Not complete
<b>5</b> Complete any terminal steps that are not automatically performed by the AER such as alcohol flush.	Complete	Not complete
<b>6</b> Thoroughly dry the forceps elevator recess after cleaning and disinfection by your AER. Insufficiently drying may cause the bacterial proliferation and pose an infection control risk.	Complete	Not complete
<b>Evaluation of the “Cleaning and Disinfection using an Automated Endoscope Reprocessor”</b>	No deviation	Deviation

Deviation Comments:

## Overall Evaluation

**Evaluation of the “Cleaning and Disinfection of the TJF-Q180V”**

No deviation

Deviation

This checklist is intended for Americas and Oceania. For other areas, the described steps may be subject to change.  
Olympus is a registered trademark of Olympus Corporation, Olympus America Inc., and/or their affiliates.



**OLYMPUS AMERICA INC.**  
3500 Corporate Parkway, PO Box 610, Center Valley, PA 18034

For more information, contact your Olympus  
sales representative, or call 800-848-9024.  
[www.medical.olympusamerica.com](http://www.medical.olympusamerica.com)

©2016 Olympus America Inc. All rights reserved.  
Printed in USA OAI0116BRO17687